

HOUSTON LIVESTOCK SHOW AND RODEO™

**DONKEY & MULE
SHOW**

PATTERN BOOK

March 18 – 19, 2023

HOUSTON LIVESTOCK SHOW AND RODEO™

DONKEY AND MULE

TRAIL

CLASS 3 - WALK TROT 5 - 10 YRS DONKEY OR MULE

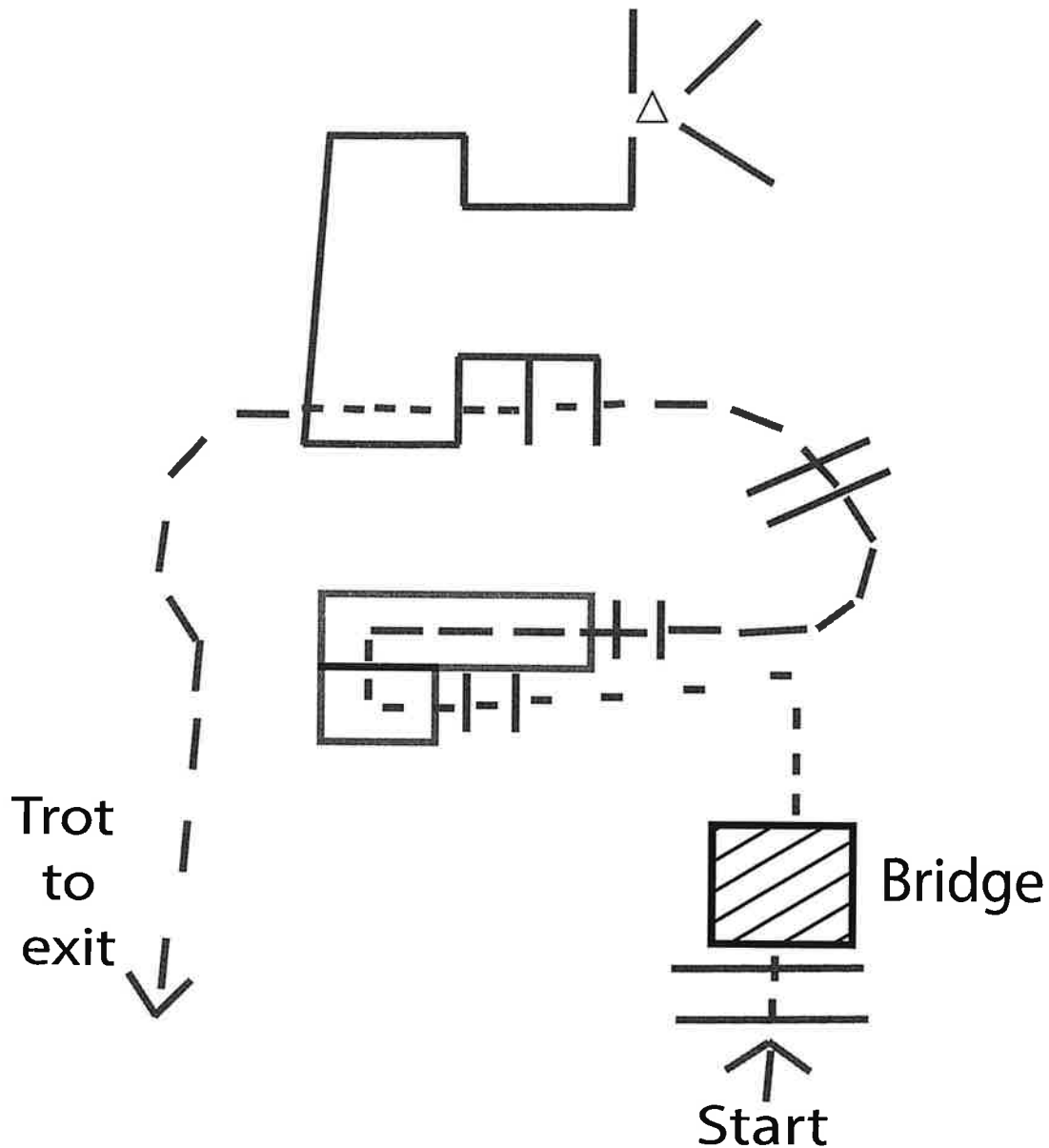

1. Walk over poles, bridge and through box
2. Trot out of large box and over poles
3. Break to a walk over 4 poles
4. Trot to exit

PATTERNS PROVIDED BY:

HOUSTON LIVESTOCK SHOW AND RODEO™

DONKEY AND MULE

TRAIL

CLASS 4 -DONKEY 19 & OVER, CLASS 5- DONKEY YOUTH, CLASS 6- MULE 19 & OVER
CLASS 7- MULE AM, CLASS 8- MULE YOUTH

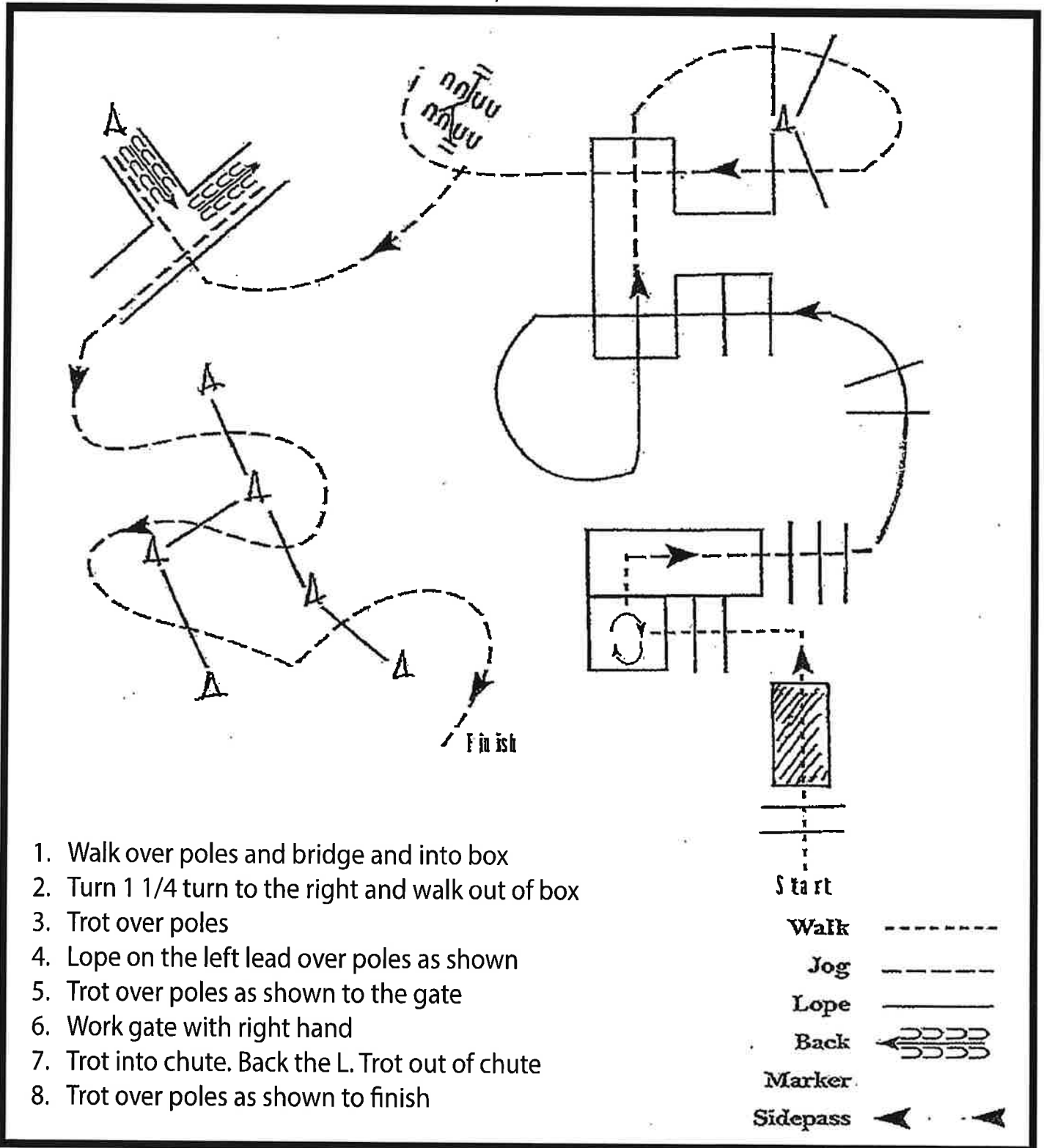

PATTERNS PROVIDED BY:

HOUSTON LIVESTOCK SHOW AND RODEO™

DONKEY AND MULE TRAIL

CLASS 1- MINI DONKEY 19 & OVER, CLASS 2- MINI DONKEY YOUTH

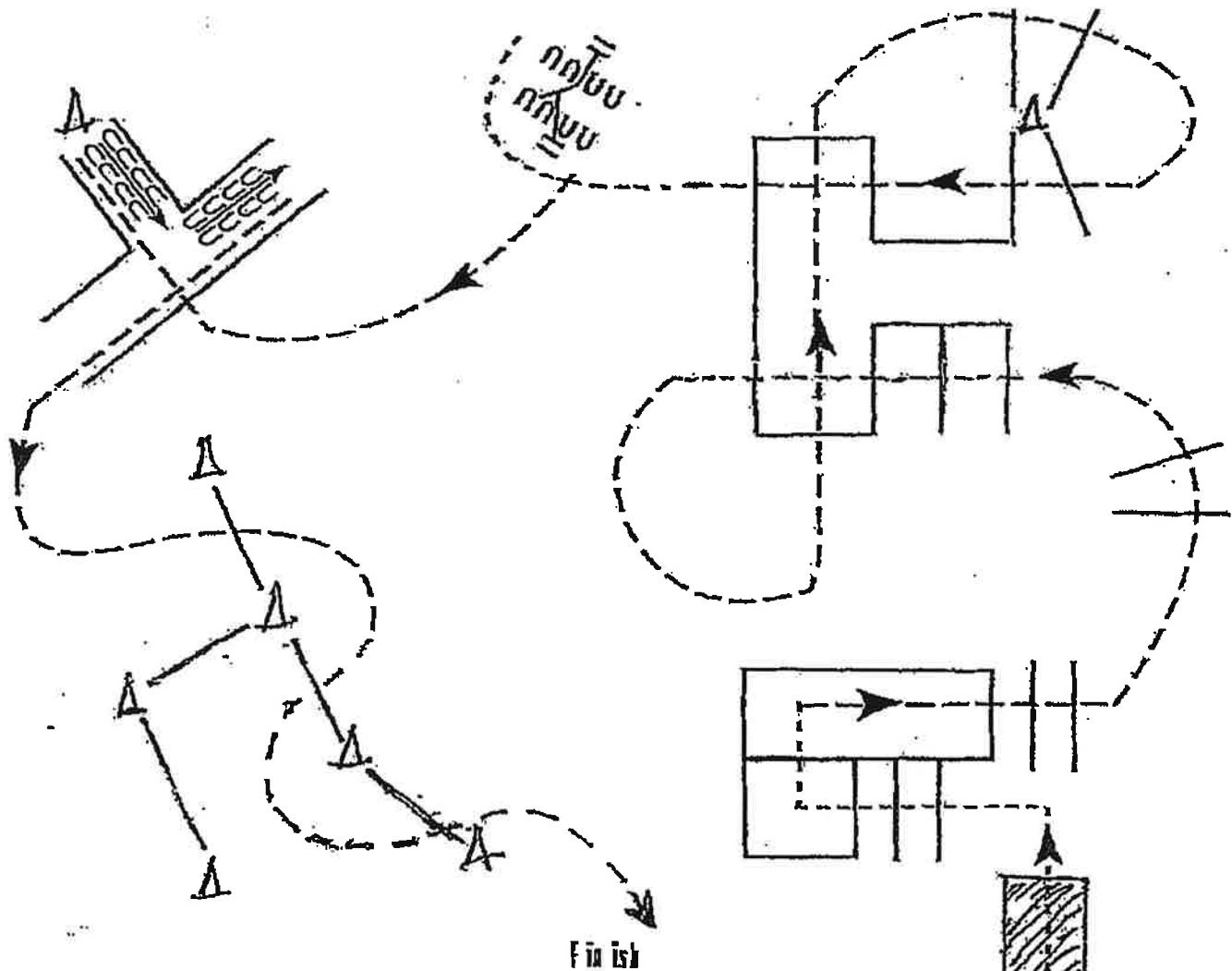

1. Walk over poles, bridge and through box
2. Trot out of large box and over poles
3. Break to a walk over the 4 poles as shown
4. Trot over poles as shown
5. Walk to gate and work with right hand
6. Trot into chute. Back the L. Trot out of chute
7. Trot over poles as shown to finish.

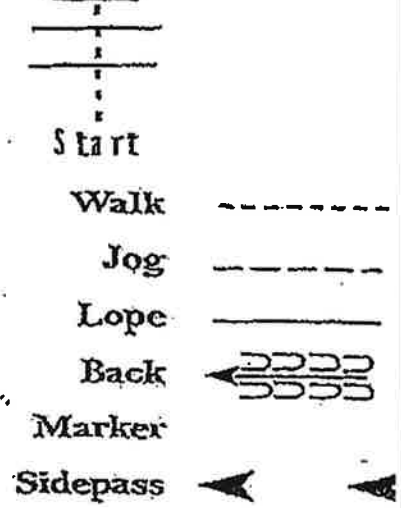

PATTERNS PROVIDED BY:

HOUSTON LIVESTOCK SHOW AND RODEO™

DONKEY AND MULE

RANCH RIDING

CLASS 9 - MULE OPEN

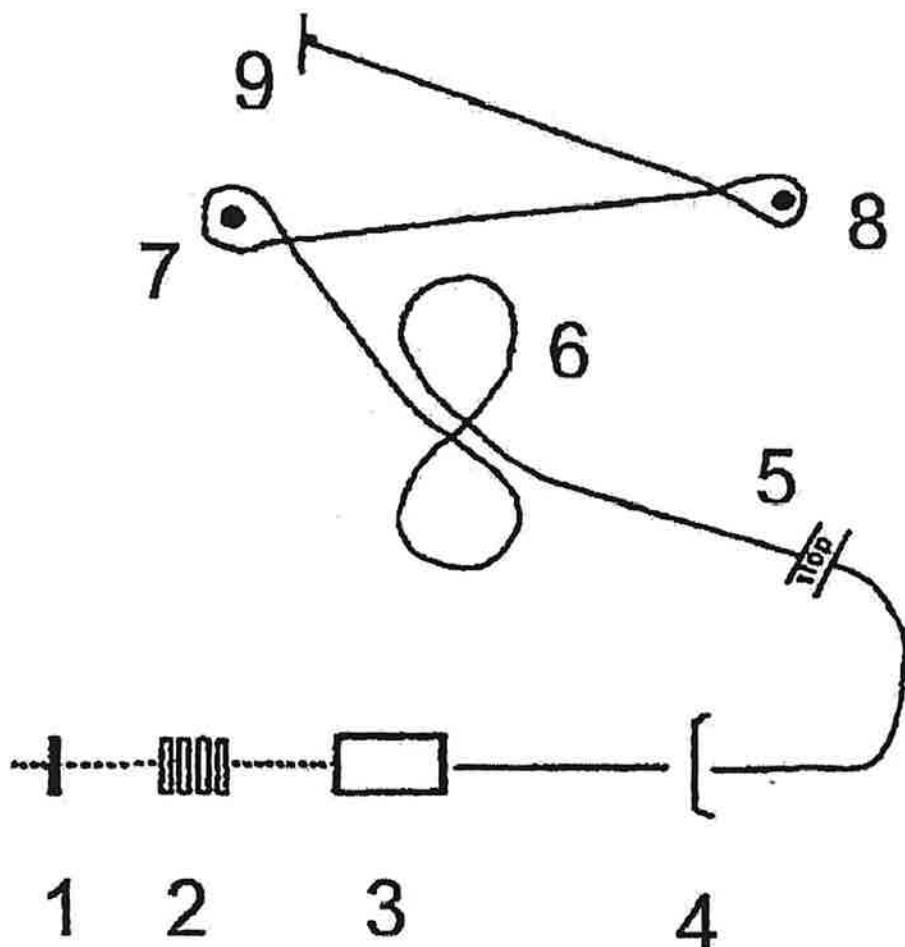

1. Work Gate
2. Walk over logs
3. Walk over bridge
4. Slow lope to and over 12" jump.
5. Stop and perform 2 spins, right or left
6. Proceed at medium lope to figure eight, showing change of lead from right to left circle.
7. Proceed with speed to barrel. Left lead
8. Proceed with speed to barrel. Right lead
9. Slide stop and back 4 steps.

PATTERNS PROVIDED BY:

HOUSTON LIVESTOCK SHOW AND RODEO™

DONKEY AND MULE

CLASS 10

REINED WORKING DONKEY OPEN

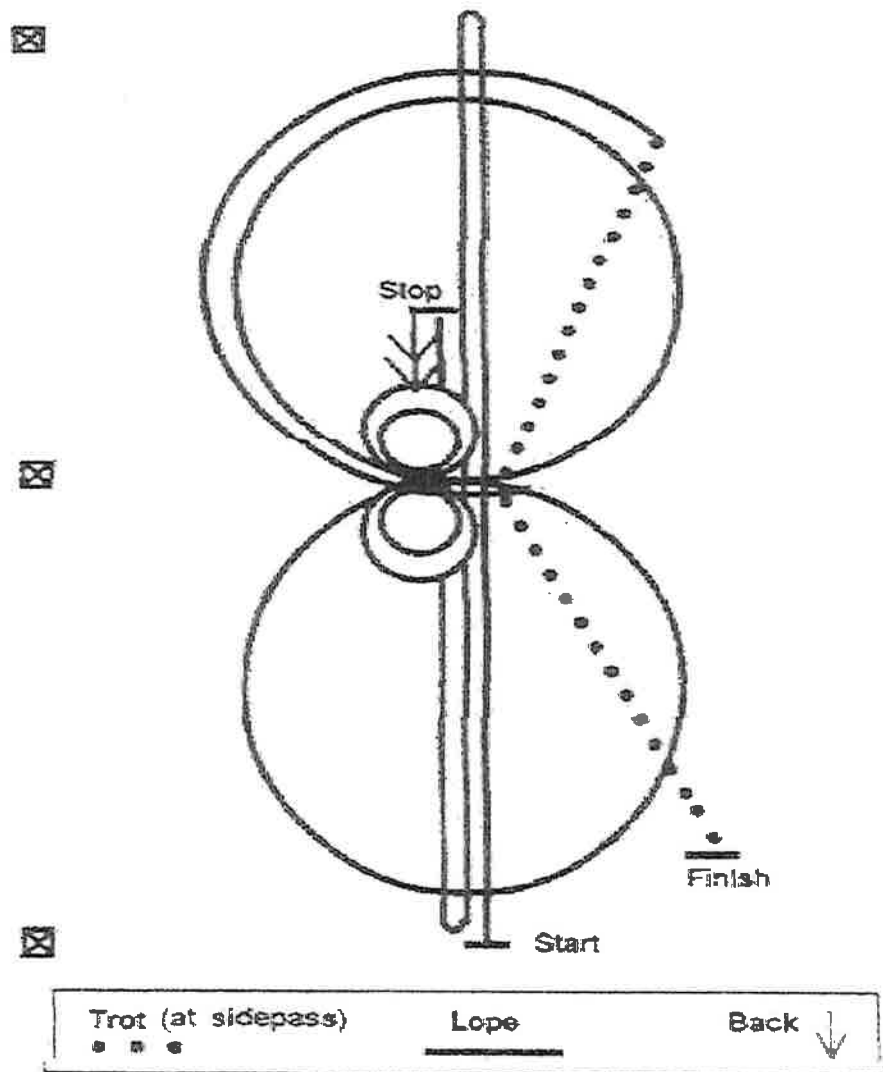

1. Run at speed to the far end of the arena past the end marker and do a left rollback—no hesitation.
2. Run to opposite end of arena past the end marker and do a right rollback—no hesitation.
3. Run past the center marker and stop. Back to the center of the arena (at least 10 feet). Hesitate.
4. Complete 2 spins to the right.
5. Complete 2 1/4 spins to the left. Hesitate.
6. Complete one large circle to the right at a lope, and at the center of the arena change to the left lead.
7. Complete one large circle to the left at the lope, and at the center of the arena change to the right lead.
8. Begin a large circle to the right and at the end markers, break to a trot.
9. At the trot. Side pass to the right to the center of the arena.
10. At the center, without hesitation, side pass to the left end marker.
11. Stop. Acknowledge judge for dismissal.

PATTERNS PROVIDED BY:

HOUSTON LIVESTOCK SHOW AND RODEO™

DONKEY AND MULE

CLASS 11

REINING MULE OPEN

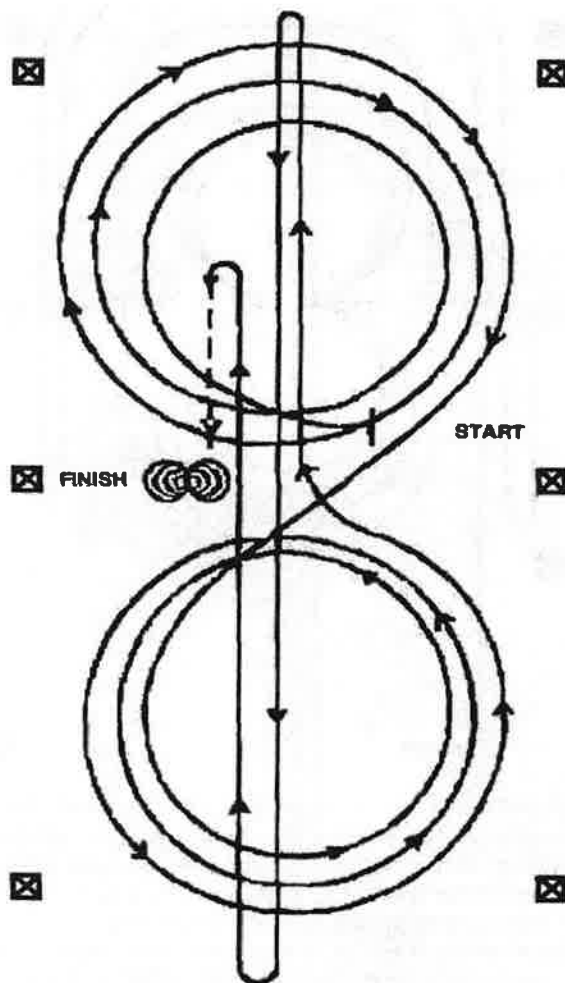

Beginning at the center of the arena facing the left wall or fence.

1. Beginning on the right lead, complete 3 circles to the right: the first circle small and slow; the next two circles large and fast. Change leads at the center of the arena.
2. Complete 3 circles to the left: the first circle small and slow; the next 2 circles large and fast. Change leads at the center of the arena.
3. Run up the middle to the far end of the arena past the end marker and do a left rollback - no hesitation.
4. Run to the opposite end of the arena past the end marker and do a right rollback - no hesitation.
5. Run past the center marker and do a sliding stop. Back up to the center of the arena or at least 10 feet. Hesitate.
6. Complete 4 spins to the right.
7. Complete 4 spins to the left. Hesitate to demonstrate the completion of the pattern.

Rider may drop bridle to the judge.

PATTERNS PROVIDED BY:

HOUSTON LIVESTOCK SHOW AND RODEO™

DONKEY AND MULE

CLASS 18 & 19 - DONKEYMANSHIP 19 & OVER AND YOUTH
CLASS 20-22 - MULEMANSHIP 19 & OVER, AMATEUR, YOUTH

Begin before A at a jog.

1. Jog from A to B.
2. At B, lope on the left lead and circle at B as shown. Stop facing B.
3. Turn 1 1/4 turn to the left.
4. Back one horse length.
5. Lope on the right lead to C. Stop at C.

Follow the instructions of your ring steward.

Walk	-----
Jog	-----
Extended Jog	-----
Lope	—————
Leg Yield	
Lead Change	—/—
Back	←←←←← ←←←←←
Marker	Ⓟ
Sidepass	←←←←←

PATTERNS PROVIDED BY:

HOUSTON LIVESTOCK SHOW AND RODEO™

DONKEY AND MULE

SHOWMANSHIP

CLASS 34 - MINI DONKEY 19 & OVER

CLASS 26 - 27 - MULE 19 & OVER AND AM, CLASS 40 - DONKEY 19 & OVER

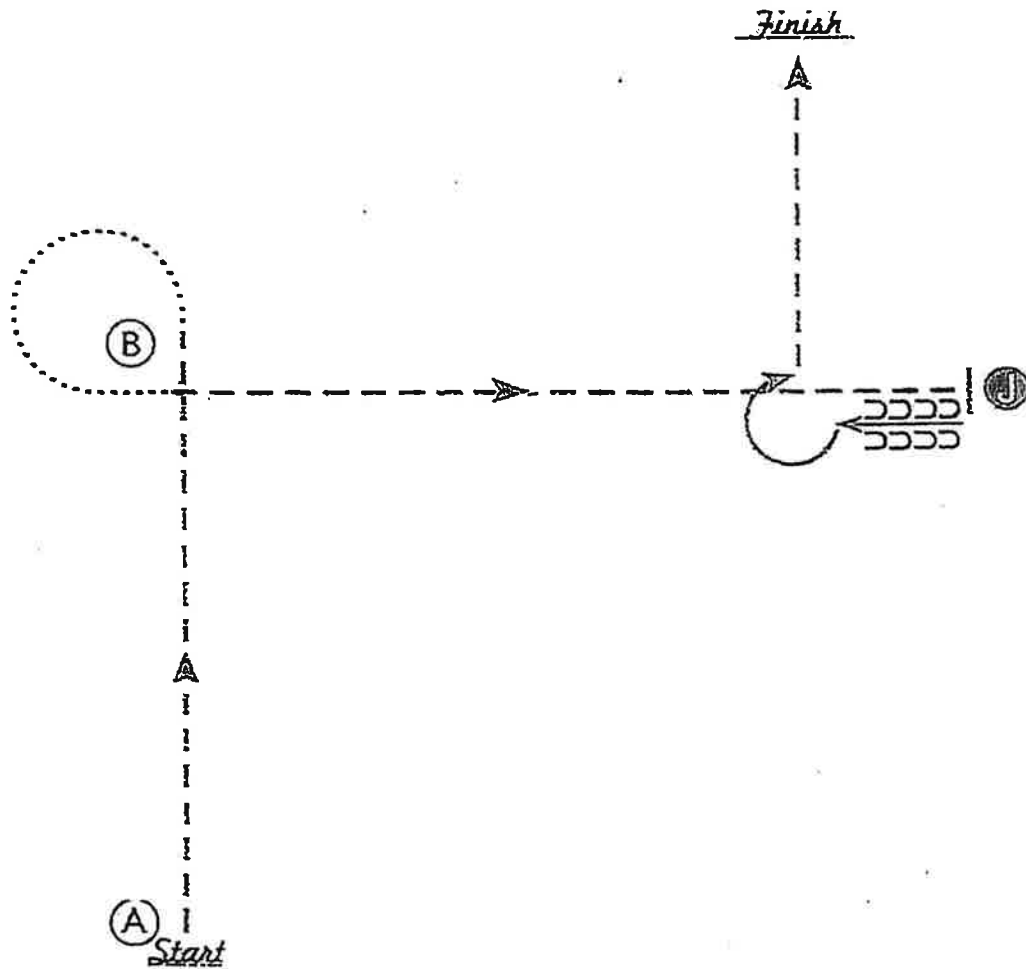

1. Trot from A to B.
2. Walk around B.
3. Trot to the judge and set-up for inspection.
4. Back one horse length.
5. Turn 270 degrees to the right.
6. Trot to exit.

PATTERNS PROVIDED BY:

HOUSTON LIVESTOCK SHOW AND RODEO™

DONKEY AND MULE

SHOWMANSHIP

CLASS 29 - MULE OR DONKEY W/T 5-10 YRS, CLASS 35 - MINI DONKEY YOUTH

CLASS 41 - DONKEY YOUTH, CLASS 28 - MULE YOUTH

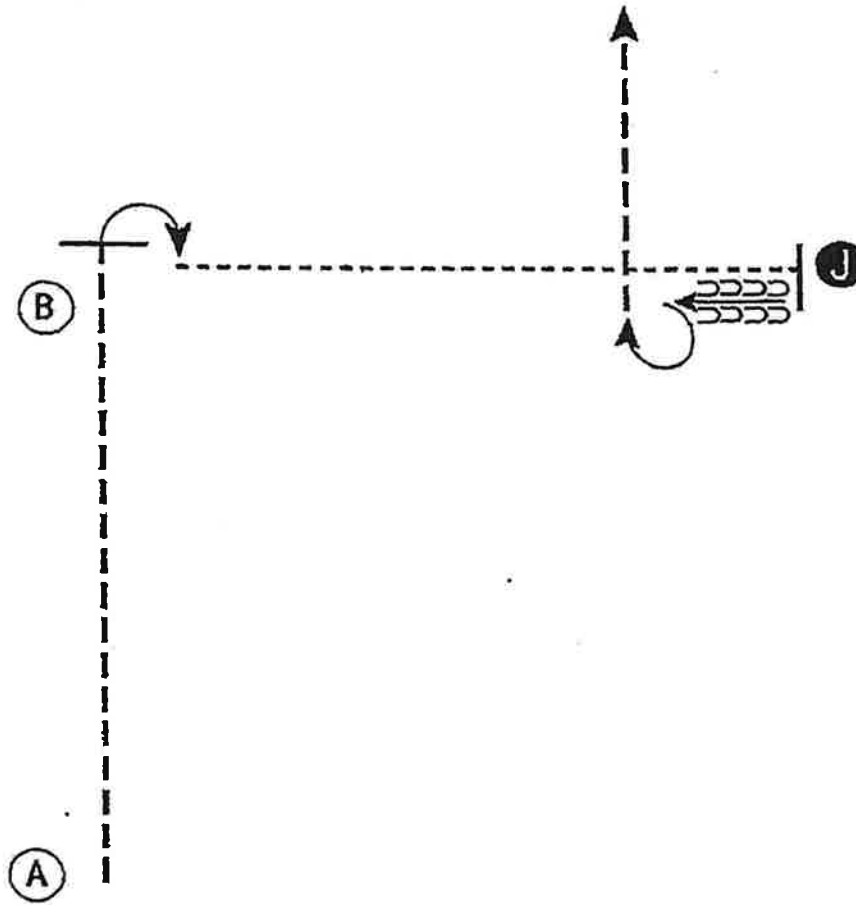

1. Begin at A. Trot from A past B
2. Stop and perform a 90 degree turn
3. Walk to the Judge, stop and set up for inspection
4. When dismissed back one horse length and perform a 270 degree turn
5. Trot to the line-up

Walk	-----
Trot	—————
Back	←————— —————
Marker	Ⓟ
Judge	●

PATTERNS PROVIDED BY:

HOUSTON LIVESTOCK SHOW AND RODEO™

DONKEY AND MULE

HUNTER HACK

CLASS 42 - 44 - MULE 19 & OVER, AMATEUR, YOUTH

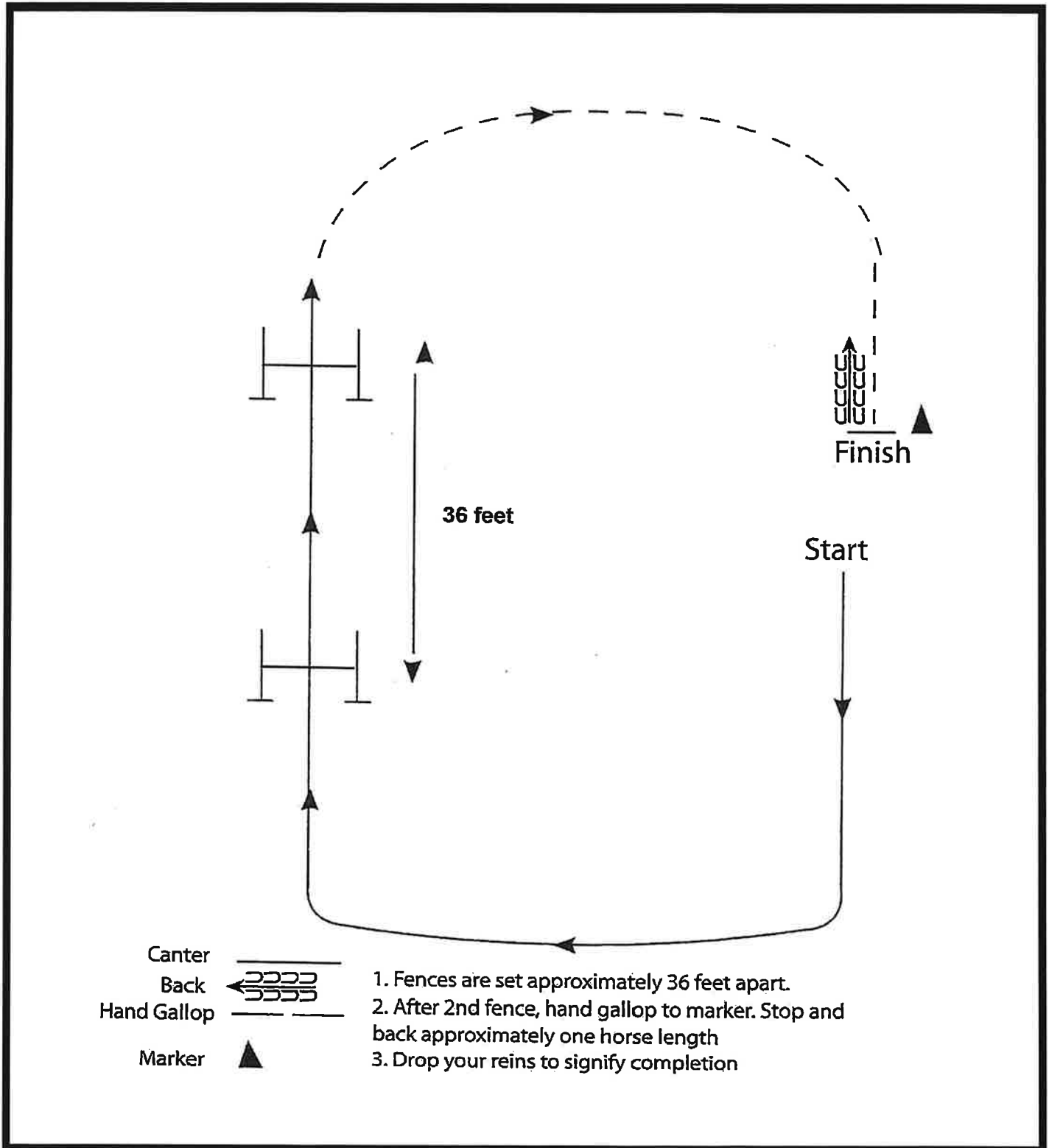

PATTERNS PROVIDED BY:

HOUSTON LIVESTOCK SHOW AND RODEO™

DONKEY AND MULE

OBSTACLE DRIVING

ALL OBSTACLE DRIVING

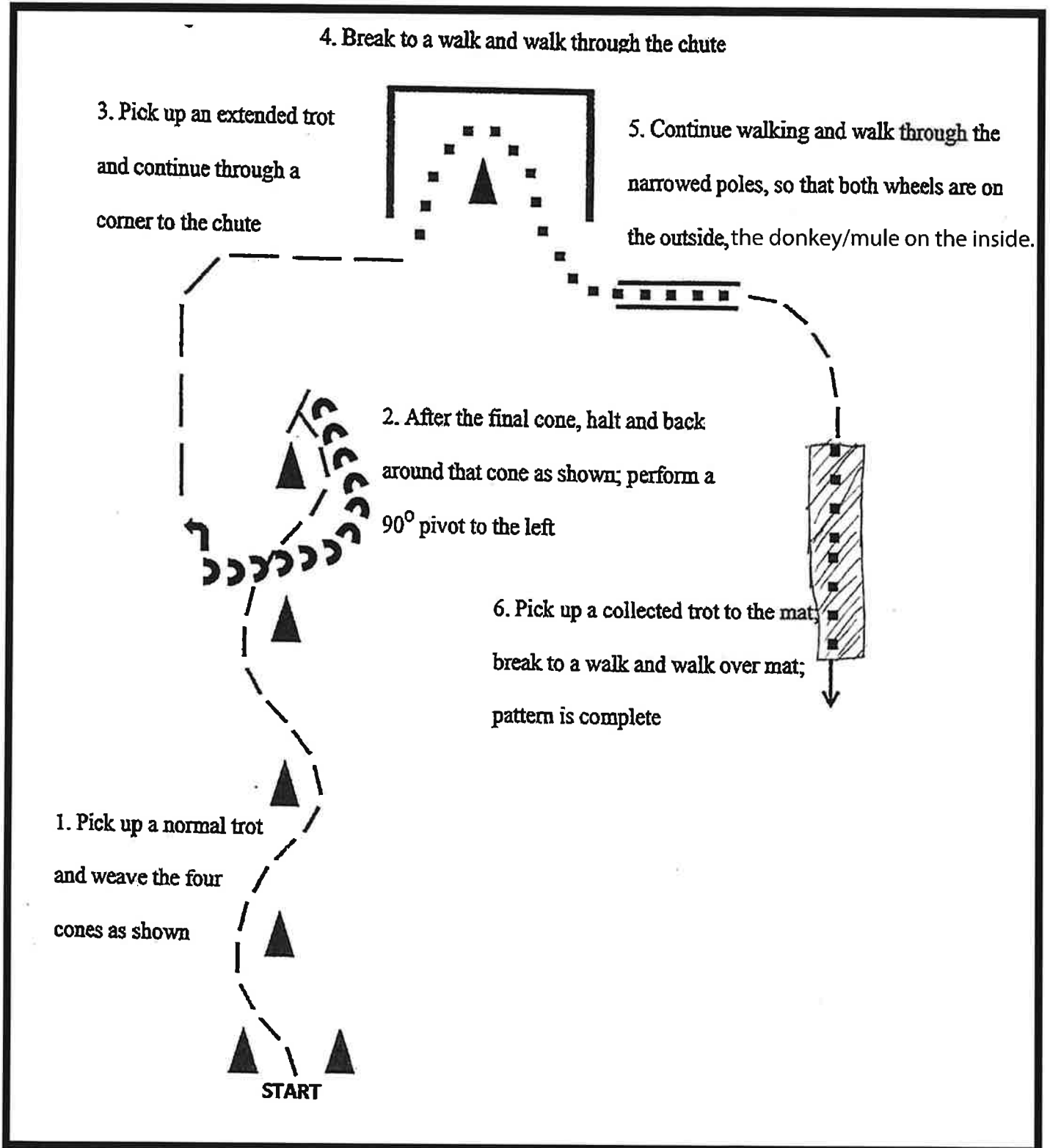

PATTERNS PROVIDED BY: